

# SERVICE MANUAL

INTEGRATED DC SERVO  
STEREO AMPLIFIER

## SANSUI A-900P

(Silver & Black Model)

## CLASSIQUE A-930P

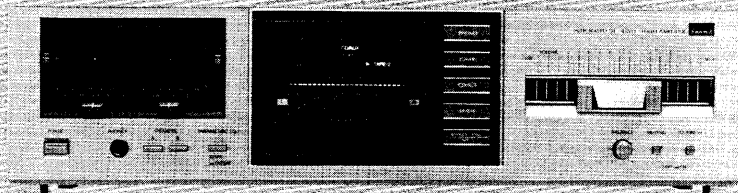

### CAUTION

1. Parts identified by the  $\Delta$  symbol on the schematic diagram and the parts list are critical for safety. Use only replacement parts that have critical characteristics recommended by the manufacturer.
2. Make leakage-current or resistance measurements to determine that exposed parts are acceptably insulated from the supply circuit before returning the appliance to the customer.

### •SPECIFICATIONS

#### (A-900P)

##### Power output

Min. RMS, both channels driven, from 20 to 20,000 Hz, with no more than 0.05% total harmonic distortion  
70 watts per channel into 8 ohms

Load impedance..... 8 ohms

##### Total harmonic distortion

..... less than 0.05% at or below rated min. RMS power output

##### Frequency response (at 1 watt)

..... 5 to 60,000 Hz  
+1 dB, -2 dB

##### RIAA curve deviation (PHONO, 20 Hz to 20 kHz)

..... +0.5 dB, -0.5 dB

##### Input sensitivity and impedance

(1 kHz, for rated power output)

PHONO..... 2.5 mV/47 kilohms

(Max. input capability; 120mV at 1 kHz, less than 0.1% total harmonic distortion)

TUNER, TAPE PLAY.... 150 mV/47 kilohms

##### Output level (1 kHz)

TAPE REC..... 130 mV into 47 kilohms

##### Signal to noise ratio (short-circuit, A-network)

PHONO..... 72 dB

TUNER, TAPE PLAY... 95 dB

##### Parametric equalizer

Equalizer frequency ... 70 Hz to 700 Hz

1 kHz to 10 kHz

Level variation range...  $\pm$ 15 dB

##### Power requirements

Power voltage..... 120/220/240V (50/60 Hz)

For U.S.A. & Canada

..... 120V (60 Hz)

Power consumption .... 265 watts 3:5 V/A Rated

360 watts Maximum

Dimensions..... 430 mm (16 1/2") W

112 mm (4 1/16") H

250 mm (9 7/8") D

Weight..... 5.9 kg (13.0 lbs.) net

6.5 kg (14.3 lbs.) packed

#### (CLASSIQUE A-930P)

Power voltage..... 120V (60 Hz)

Power consumption ..... 265 watts

Dimensions..... 430 mm (16 1/2") W

112 mm (4 1/16") H

250 mm (9 7/8") D

Weight..... 5.9 kg (13.0 lbs.) net

6.5 kg (14.3 lbs.) packed

\* Design and specifications subject to changes without notice for improvements.

\* Due to local laws and regulations, this unit sold in some areas are not equipped with variable voltage selectors.



SANSUI ELECTRIC CO., LTD.

## CAUTION

1. The symbols, UL, CSA, SA, BS, UK, EU, AS, XX <EXPORT> and XX-V <EXPORT(V)> on the parts list and the schematic diagram mean followings respectively.  
UL..... Manufactured for U.S.A market.  
(Underwriters Laboratories approved model.)  
CSA..... Manufactured for Canadian market.  
SA..... Manufactured for South African market.  
BS, UK..... Manufactured for United Kingdom market.  
EU..... Manufactured for European market.  
AS..... Manufactured for Australian market.  
XX <EXPORT>..... Standard Version with Inner Voltage Selector.  
XX-V <EXPORT(V)>.... Standard Version with Outer Voltage Selector.  
NON MARK..... Common Parts.
2. Some printed circuit boards are not supplied as the assembled.  
To separate these in this service manual, the stock No's are not indicated at the ends of the board names. However, the individual parts on the circuit boards are provided by orders.
3. Since some of capacitors and resistors are omitted from parts lists in this service manual, refer to the Common Parts List for capacitors & resistors, which was issued on February 1983.
4. Abbreviations in this service manual are as follows.

### •Abbreviations List

C.R. : Carbon Resistor	E.B.L. : Low Leak Bi-Polar
S.R. : Solid Resistor	Electrolytic Capacitor
Ce.R. : Cement Resistor	Ta.C. : Tantalum Capacitor
M.R. : Metal Film Resistor	F.C. : Film Capacitor
F.R. : Fusing Resistor	M.P. : Metalized Paper Capacitor
N.I.R. : Non-Inflammable Resistor	P.C. : Polystyrene Capacitor
A.R. : Array Resistor	G.C. : Gimmic Capacitor
C.C. : Ceramic Capacitor	A.C. : Array Capacitor
C.T. : Ceramic Capacitor,	V.R. : Variable Resistor
Temperature Compensation	S.V.R. : Semi Variable Resistor
E.C. : Electrolytic Capacitor	SW. : Switch
E.L. : Low Leak Electrolytic	Chip R. : Chip Resistor
Capacitor	Chip C. : Chip Capacitor
E.B. : Bi-Polar Electrolytic	
Capacitor	

# 1. BLOCK DIAGRAM

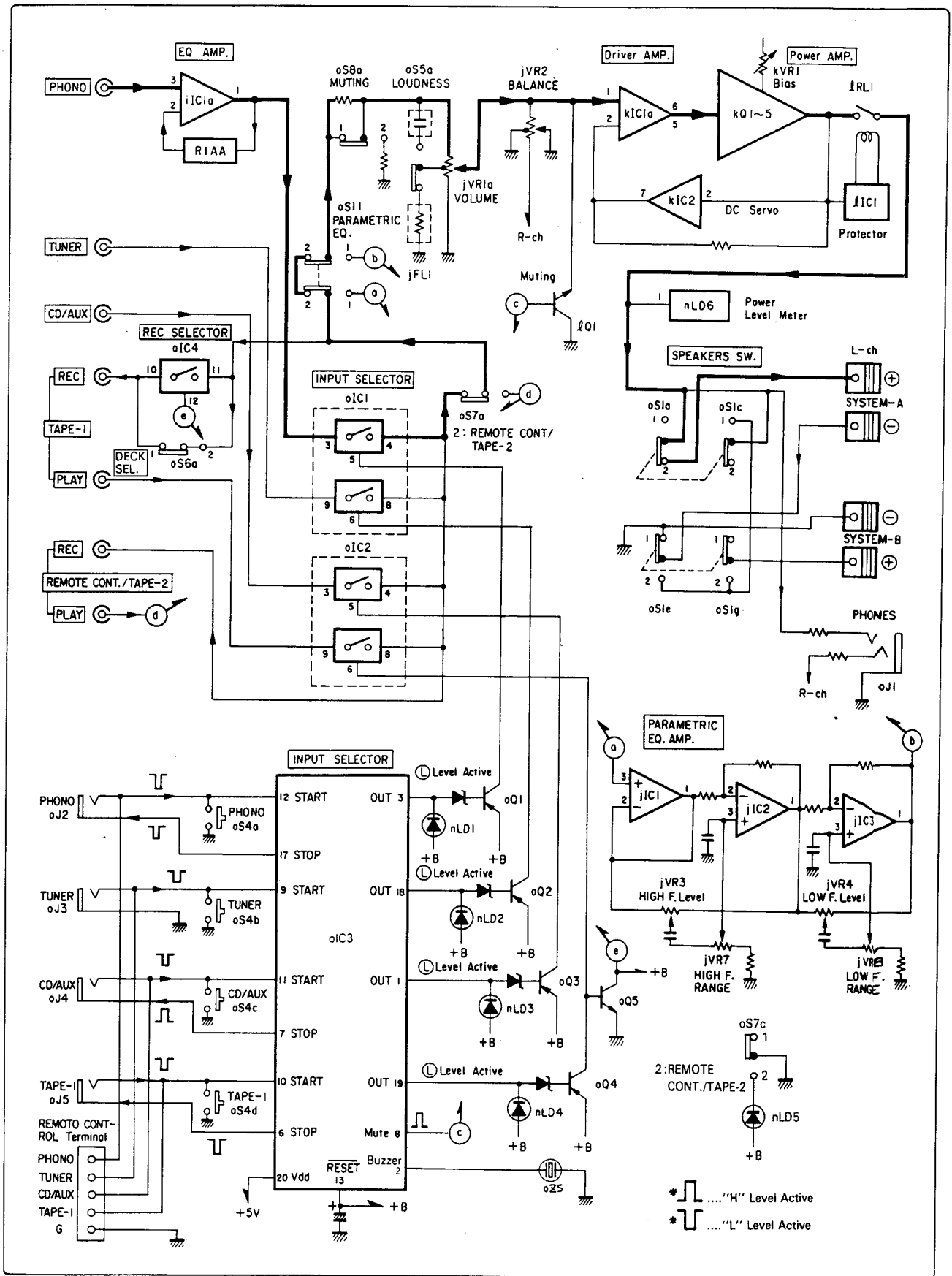

## 2. INTERIOR BLOCK DIAGRAM OF IC

•STK3082-2A (Driver Amp. IC)

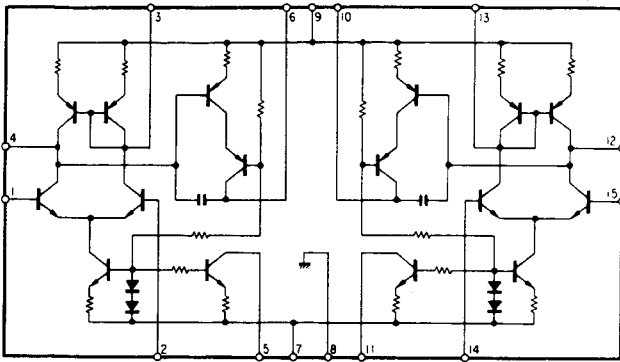

•LC4066BH/LC4966 (Quad Analog SW. IC)

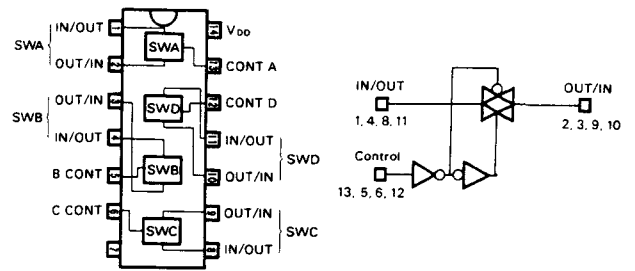

•TA7317P (Speaker Protector IC)

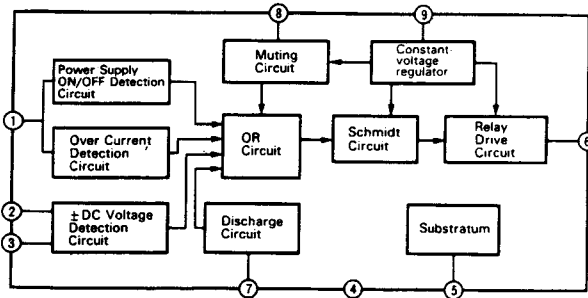

•NJM4558D (OP Amp. IC)

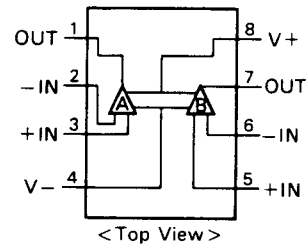

•M5218L (OP Amp. IC)

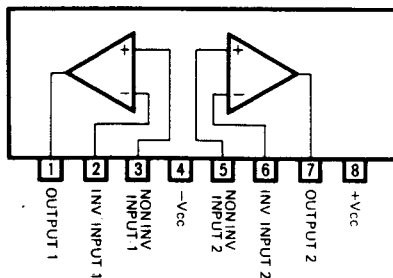

## 3. ADJUSTMENT (See Top View on page 9)

- Note:**
- 1) Master Volume .... Minimum
  - 2) Room Temperature .... 18°C ~ 28°C (65°F ~ 83°F)
  - 3) For this adjustment, run the unit for more than 5 minutes after the power is switched ON.
  - 4) Before turning ON power switch, set kVR1 on F-4762 to center position.

STEP	SUBJECT	MEASURE OUTPUT	ADJUST	ADJUST FOR	REMARKS
1.	Bias Current Adj. L-CH	Test Terminal (TP) <Between emitters of power transistors (kQ4L & kQ5L)>	kVR1, L-ch (F-4762)	DC 5mV ± 1mV	•This bias value is converted from current value to voltage by ohms law.
2.	Bias Current Adj. R-CH	Test Terminal (TP) <Between emitters of power transistors (kQ4R & kQ5R)>	kVR1, R-ch (F-4762)	DC 5mV ± 1mV	

## 4. PARTS LOCATION & PARTS LIST

### 4-1. F-4759 Equalizer Amp. Board (Stock No. 00852601)

Component Side

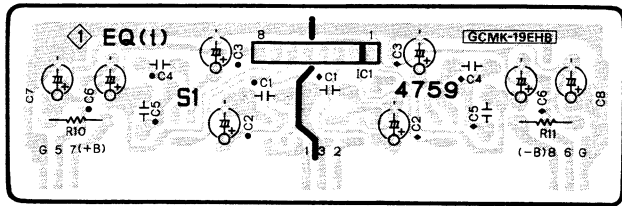

Pattern Side <Chip Parts>

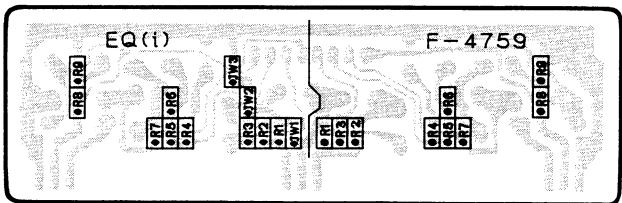

•Note: On this circuit board, the left channel is specified by "●" mark on top of the parts No.

#### Parts List

Parts No.	Stock No.	Description
•IC		
iIC1	46078900	M5218L
iJW1	46741100	Cross Conductor (Chip)
iJW2	46741100	Cross Conductor (Chip)
iJW3	46741100	Cross Conductor (Chip)
iR1	46752400	100kΩ 1/8W Chip R.
iR2	46746800	470Ω 1/8W Chip R.
iR3	46752400	100kΩ 1/8W Chip R.
iR4	46746900	510Ω 1/8W Chip R.
iR5	46746900	510Ω 1/8W Chip R.
iR6	46750800	22kΩ 1/8W Chip R.
iR7	46753500	300kΩ 1/8W Chip R.
iR8	46746800	470Ω 1/8W Chip R.
iR9	46752400	100kΩ 1/8W Chip R.
△iR10	46229000	100Ω 1/2W N.I.R.
△iR11	46229000	100Ω 1/2W N.I.R.
iC4	46282400	3300pF 50V F.C.
iC5	46283000	0.012μF 50V F.C.

### 4-2. F-4762 Driver Amp. Board (Stock No. 00877601)

Component Side

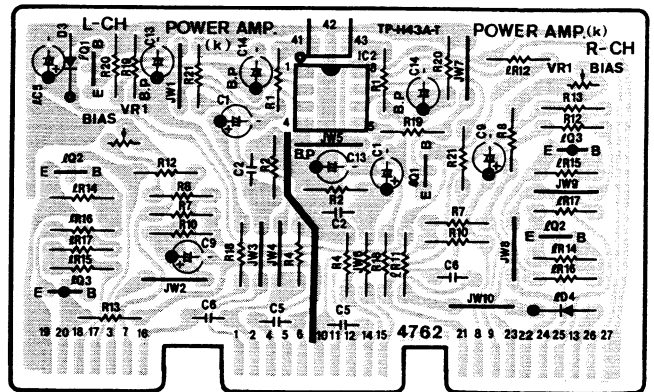

#### Parts List

Parts No.	Stock No.	Description
•IC		
kIC2	03607700	NJM4558D
△kR12	46228600	47Ω 1/2W N.I.R.
△kR13	46228600	47Ω 1/2W N.I.R.
kC13	48103500	2.2μF 50V E.B.
kC14	48102400	4.7μF 25V E.B.
kVR1	07261600	1kΩ (B) S.V.R., Bias adj.
•Transistor		
iQ1	46367301	2SC2458
	or 46581701	2SC1845
iQ2	46367101	2SC2603
	or 46367301	2SC2458
iQ3	46367001	2SA1115
	or 46367201	2SA1048
•Diode		
iD3	03117600	1S2473T77
	or 46086000	1S1588TP-3
iD4	03117600	1S2473T77
	or 46086000	1S1588TP-3

### 4-3. F-4765 Protector Board (Stock No. 00876901)

Component Side

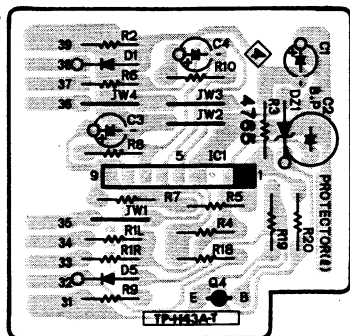

#### Parts List

Parts No.	Stock No.	Description
•IC		
iIC1	46207600	TA7317P
•Diode		
iD1	03117600	1S2473T77
	or 46086000	1S1588TP-3
iC2	48101500	100μF 6.3V E.B.

**4-4. F-4766 INPUT SELECTOR Control Board**  
(Stock No. 00877001)

Component Side

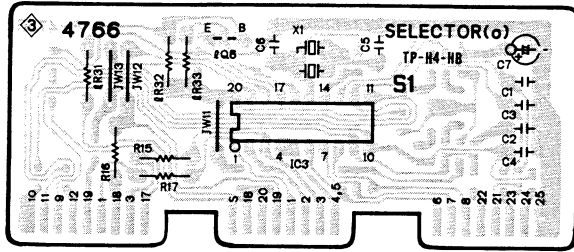

Pattern Side < Chip Parts >

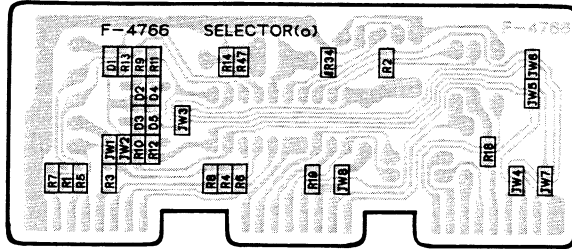

**4-5. F-4767 Input Signal Selector Board**  
(Stock No. 00877101)

Component Side

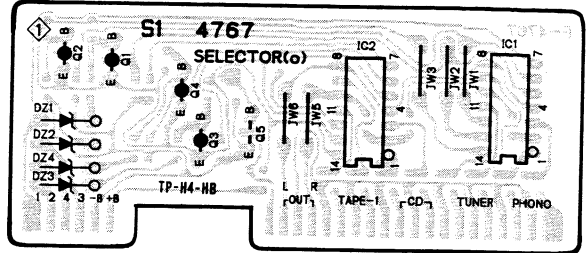

Pattern Side < Chip Parts >

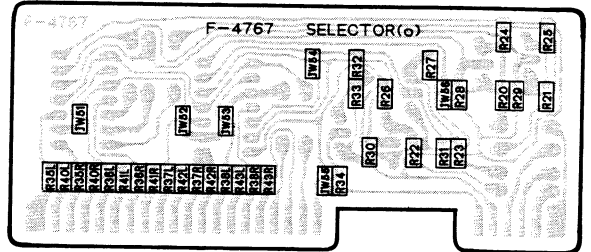

**Parts List**

Parts No.	Stock No.	Description
•IC		
oIC3	48158300	M50761-450P
oX01	46396200	Ceramic Element CSB400P
•Diode		
oD1	46852000	RLS-73 (Chip)
oD2	46852000	RLS-73 (Chip)
oD3	46852000	RLS-73 (Chip)
oD4	46852000	RLS-73 (Chip)
oD5	46852000	RLS-73 (Chip)
oJW1~8	46741100	Cross Conductor (Chip)
oR1	46748000	1.5kΩ 1/8W Chip R.
oR2	46748000	1.5kΩ 1/8W Chip R.
oR3	46748000	1.5kΩ 1/8W Chip R.
oR4	46748000	1.5kΩ 1/8W Chip R.
oR5	46748000	1.5kΩ 1/8W Chip R.
oR6	46748000	1.5kΩ 1/8W Chip R.
oR7	46748000	1.5kΩ 1/8W Chip R.
oR8	46748000	1.5kΩ 1/8W Chip R.
oR9	46750000	10kΩ 1/8W Chip R.
oR10	46750000	10kΩ 1/8W Chip R.
oR11	46750000	10kΩ 1/8W Chip R.
oR12	46750000	10kΩ 1/8W Chip R.
oR13	46752400	100kΩ 1/8W Chip R.
oR14	46754800	1MΩ 1/8W Chip R.
oR18	46746600	390Ω 1/8W Chip R.
oR19	46751800	56kΩ 1/8W Chip R.
oR46	46750000	10kΩ 1/8W Chip R.
oR47	46748700	3kΩ 1/8W Chip R.

**Parts List**

Parts No.	Stock No.	Description
•Transistor		
oQ1	46188601	2SA1015
	or 46367001	2SA1115
	or 46367201	2SA1048
oQ2	46188601	2SA1015
	or 46367001	2SA1115
	or 46367201	2SA1048
oQ3	46188601	2SA1015
	or 46367001	2SA1115
	or 46367201	2SA1048
oQ4	46188601	2SA1015
	or 46367001	2SA1115
	or 46367201	2SA1048
oQ5	46188701	2SC1815
	or 46367101	2SC2603
	or 46367301	2SC2458
•IC		
oIC1	46255000	LC4066BH
	or 48056800	LC4966
oIC2	46255000	LC4066BH
	or 48056800	LC4966
•Zener Diode		
oDZ1	46112700	05Z8.2-Y
oDZ2	46112700	05Z8.2-Y
oDZ3	46112700	05Z8.2-Y
oDZ4	46112700	05Z8.2-Y
oJW51~56	46741100	Cross Conductor (Chip)
oR20	46747200	680Ω 1/8W Chip R.
oR21	46747200	680Ω 1/8W Chip R.
oR22	46747200	680Ω 1/8W Chip R.
oR23	46747200	680Ω 1/8W Chip R.
oR24	46749200	4.7kΩ 1/8W Chip R.
oR25	46749200	4.7kΩ 1/8W Chip R.
oR26	46749200	4.7kΩ 1/8W Chip R.
oR27	46749200	4.7kΩ 1/8W Chip R.
oR28	46751600	47kΩ 1/8W Chip R.
oR29	46751600	47kΩ 1/8W Chip R.
oR30	46751600	47kΩ 1/8W Chip R.
oR31	46751600	47kΩ 1/8W Chip R.
oR32	46750800	22kΩ 1/8W Chip R.
oR33	46749200	4.7kΩ 1/8W Chip R.
oR34	46751600	47kΩ 1/8W Chip R.
oR35	46749200	4.7kΩ 1/8W Chip R.
oR36	46749200	4.7kΩ 1/8W Chip R.
oR37	46749200	4.7kΩ 1/8W Chip R.
oR38	46749200	4.7kΩ 1/8W Chip R.
oR40	46754000	470kΩ 1/8W Chip R.
oR41	46754000	470kΩ 1/8W Chip R.
oR42	46754000	470kΩ 1/8W Chip R.
oR43	46754000	470kΩ 1/8W Chip R.

4-6. F-4769 CD/AUX, TAPE-1 & TAPE-2 Terminal Board (Stock No. 00877201)

Component Side

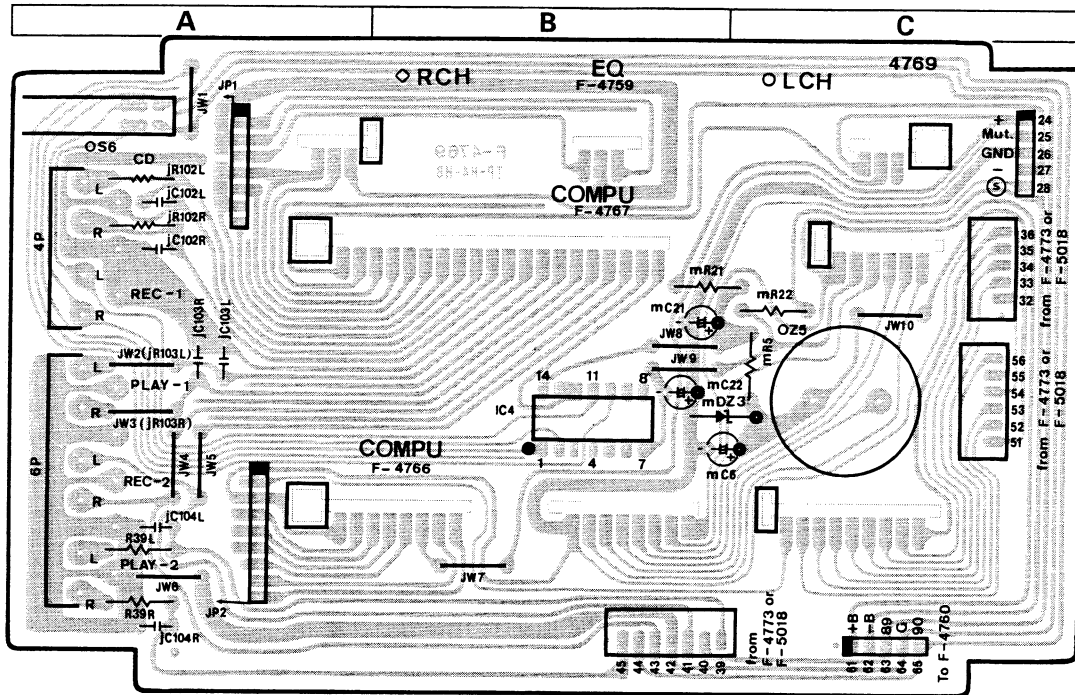

Parts List

Parts No.	Stock No.	Description
• Zener Diode		
mDZ3	46100900	05Z5.1-X
△ mR5	46229600	330Ω 1/2W N.I.R.
• IC		
oIC4	46255000 or 48056800	LC4066BH LC4966

Parts No.	Stock No.	Description
• Diode		
oD6	07176400	1S2473HS
oS6	46670600	Push SW., DECK SELECTOR
oZ3	46546800	6P Terminal, TAPE-1 PLAY, TAPE-2
oZ5	48178400	Buzzer
oZ6	46371500	4P Terminal, CD/AUX, TAPE-1 REC

4-7. F-4770 PHONO, TUNER COMPU SELECTOR Terminal Board

Component Side

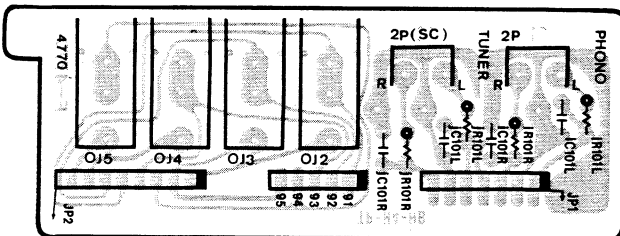

Parts List

Parts No.	Stock No.	Description
oJ2	46547200	Jack, PHONO (COMPU SELECTOR)
oJ3	46547200	Jack, TUNER (COMPU SELECTOR)
oJ4	46547200	Jack, CD/AUX (COMPU SELECTOR)
oJ5	46547200	Jack, TAPE-1 (COMPU SELECTOR)
oZ2	46438100	2P Terminal, PHONO
oZ7	46363700	2P Terminal, TUNER

4-8. F-4781 HIGH F. RANGE Indicator Board

Component Side

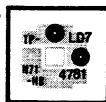

Parts List

Parts No.	Stock No.	Description
• LED		
nLD7	48200300	EBR2201S

4-9. F-4782 LOW F. RANGE Indicator Board

Component Side

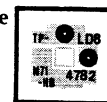

Parts List

Parts No.	Stock No.	Description
• LED		
nLD8	48200300	EBR2201S

4-10. F-4775 Power Amp. & Power Supply Board (Stock No. 00895601 = A-900P <XX,XX-V,UL,CSA> & CLASSIQUE A-930P  
(Stock No. 00895605 = A-900P <EU,BS>)

Component Side

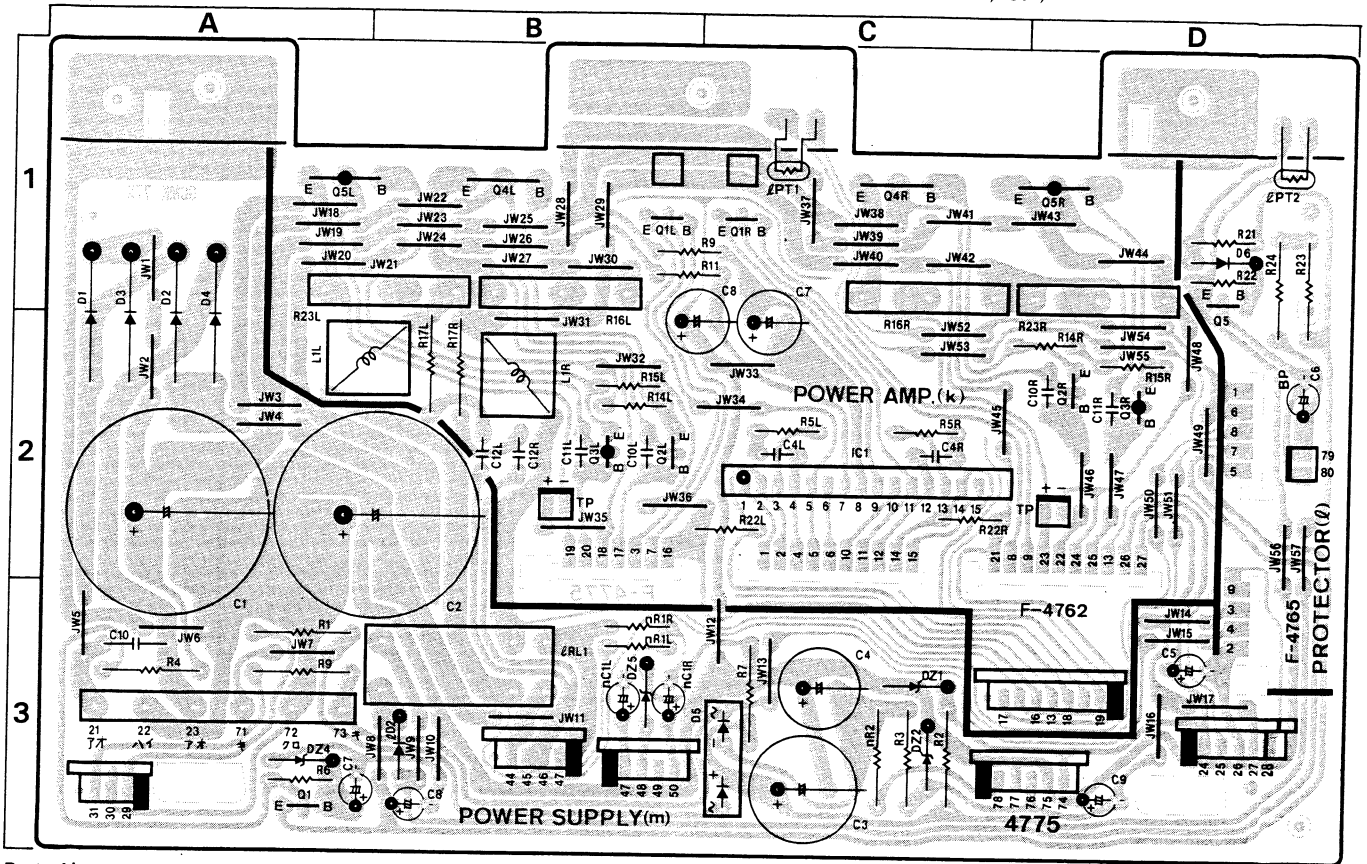

Parts List

Parts No.	Stock No.	Description
• Transistor		
△kQ1	03067401	2SC1845
△kQ2	07206401	2SD600K
△kQ3	07206301	2SB631K
△kQ4	48120101	2SC3182
△	or 48187101	2SC2837
△kQ5	48120001	2SA1265
△	or 48187001	2SA1186
• IC		
△kIC1	46921800	STK3082-2A
△kR9	46228600	47Ω 1/2W N.I.R.
△kR11	46229000	100Ω 1/2W N.I.R.
△kR14	46229200	150Ω 1/2W N.I.R.
△kR15	46229200	150Ω 1/2W N.I.R.
△kR16	07235100	0.47ΩX2 5W Ce.R.
△kR17	46248100	10Ω 1W N.I.R.
△kR23	07235100	0.47ΩX2 5W Ce.R.
kC12	46283700	0.047μF 50V F.C.
kl1	46394500	Inductor Coil
	or 46394501	Inductor Coil
• Transistor		
IQ5	48061801	2SC3244 (A-900P <EU, BS>)
• Diode		
ID2	48123600	11E-2
ID6	03117600	1S2473T77 (A-900P <EU, BS>)
△IPT2	48193000	Posistor E471TS (A-900P <EU, BS>)
△IR23	46249300	100Ω 1W N.I.R. (A-900P <EU, BS>)

Parts No.	Stock No.	Description
△IR24	46249300	100Ω 1W N.I.R. (A-900P <EU, BS>)
IC6	48103600	33μF 50V E.B. (A-900P <EU, BS>)
IRL1	48183100	Relay
	or 48183200	Relay
• Transistor		
△mQ1	46581701	2SC1845
• Diode		
△mD1	03115300	30D2
△mD2	03115300	30D2
△mD3	03115300	30D2
△mD4	03115300	30D2
△mD5	03117000	RB152-LFF
• Zener Diode		
mDZ1	03170300	RD12F B
	or 48074700	EQB01-12-S
mDZ2	03170300	RD12F B
	or 48074700	EQB01-12-S
mDZ4	46116000	05Z24-Y
mDZ5	03169900	RD10F-B
	or 03156000	EQB01-10
△mR1	46248700	33Ω 1W N.I.R.
△mR2	46249500	150Ω 1W N.I.R.
△mR3	46249600	180Ω 1W N.I.R.
△mR4	46250400	820Ω 1W N.I.R.
△mR7	46624400	120Ω 2W N.I.R.
△mR9	46248700	33Ω 1W N.I.R.
mC1	08301800	6800μF 63V E.C.
mC2	08301800	6800μF 63V E.C.
mC10	08680400	0.01μF 500V C.C.



**4-11. F-4780 PARAMETRIC EQ. V.R. Board  
Component Side**

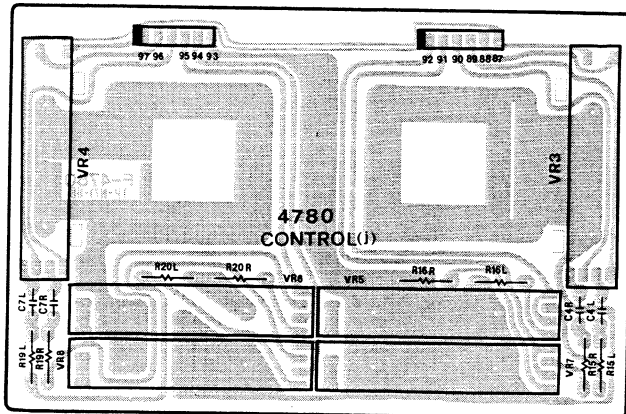

**Parts List**

Parts No.	Stock No.	Description
jC4	46282200	2200pF 50V F.C.
jC7	46283500	0.033 $\mu$ F 50V F.C.
jVR3	48196700	10k $\Omega$ (B) V.R., HIGH F. Level
jVR4	48196700	10k $\Omega$ (B) V.R., LOW F. Level
jVR5	48196600	100k $\Omega$ (C) V.R., HIGH F. RANGE
jVR6	48196600	100k $\Omega$ (C) V.R., LOW F. RANGE
jVR7	48196500	100k $\Omega$ (C) V.R., HIGH F. RANGE
jVR8	48196500	100k $\Omega$ (C) V.R., LOW F. RANGE

**4-12. F-4783 PARAMETRIC EQ. Amp. Board  
Component Side**

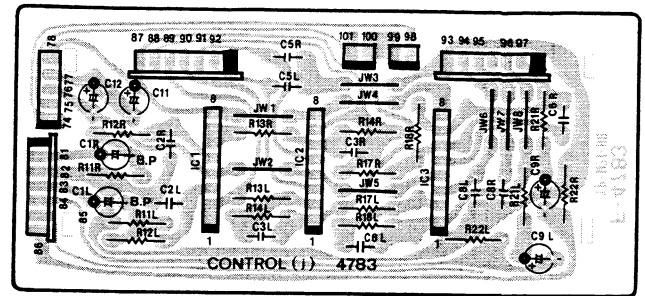

**Parts List**

Parts No.	Stock No.	Description
<b>•IC</b>		
jIC1	46078900	M5218L
jIC2	46078900	M5218L
jIC3	46078900	M5218L
jC1	48103400	1 $\mu$ F 50V E.B.
jC5	46281800	1000pF 50V F.C.
jC8	46283100	0.015 $\mu$ F 50V F.C.

**4-13. F-4785 SPEAKERS Terminal & Power SW. Board  
Component Side**

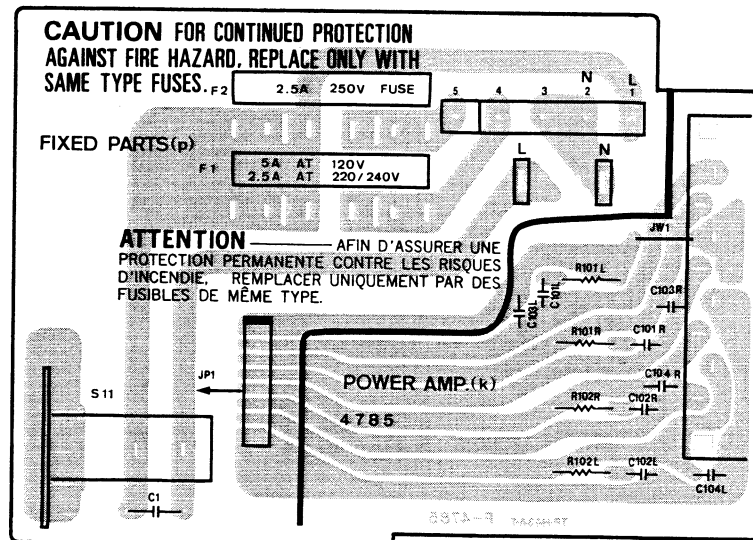

**Parts List**

Parts No.	Stock No.	Description
oZ4	46947500	8P Terminal, SPEAKERS
$\Delta$ pC1	46425800	0.01 $\mu$ F 400V C.C.
$\Delta$	or 46943200	0.01 $\mu$ F 400V C.C.
$\Delta$ pF1	07188700	Fuse 2.5A 250V for A-900P (XX 220V/240V, XX-V)
$\Delta$	07189100	Fuse 5.0A 250V for A-900P (XX-120V, UL, CSA) & CLASSIQUE A-930P

Parts No.	Stock No.	Description
$\Delta$	07185000	Fuse 2.0A 250V for A-900P (EU, BS)
$\Delta$ pF2	07188700	Fuse 2.5A 250V for A-900P (XX-V)
$\Delta$ pS11	48113300	Push SW., POWER for A-900P (XX, XX-V, UL, EU, BS) & CLASSIQUE A-930P
$\Delta$	48065100	Push SW., POWER for A-900P (CSA)

**4-14. F-4784 SPEAKERS SW. Board  
Component Side**

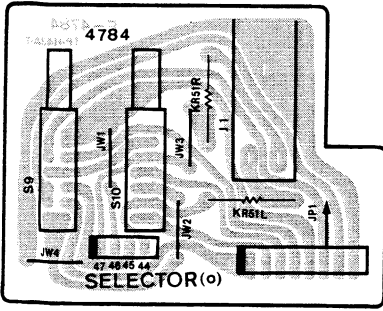

**Parts List**

Parts No.	Stock No.	Description
ΔKR51	46229400	220Ω 1/2W N.I.R.
oS9	46941800	Push SW., SPEAKERS-B
oS10	46941800	Push SW., SPEAKERS-A
oJ1	46265700	Jack, PHONES

**4-15. F-5019 VOLUME Board  
Component Side**

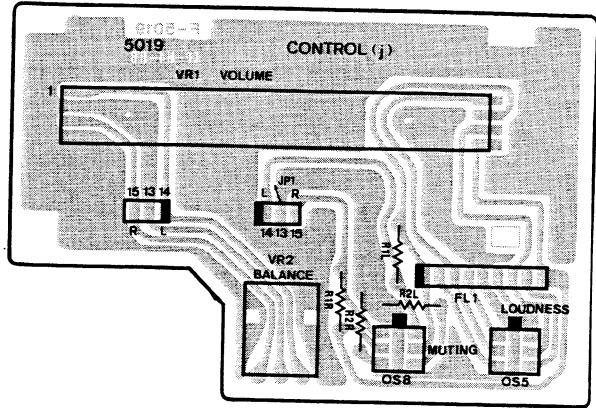

**Parts List**

Parts No.	Stock No.	Description
jFL1	48172000	CR Module
jVR1	48171000	150kΩ (B) V.R., VOLUME
jVR2	48196400	250kΩW V.R., BALANCE
oS5	48224600	Push SW., LOUDNESS
oS8	48224600	Push SW., MUTING

**4-16. F-5018 INPUT SELECTOR SW. Board  
Component Side**

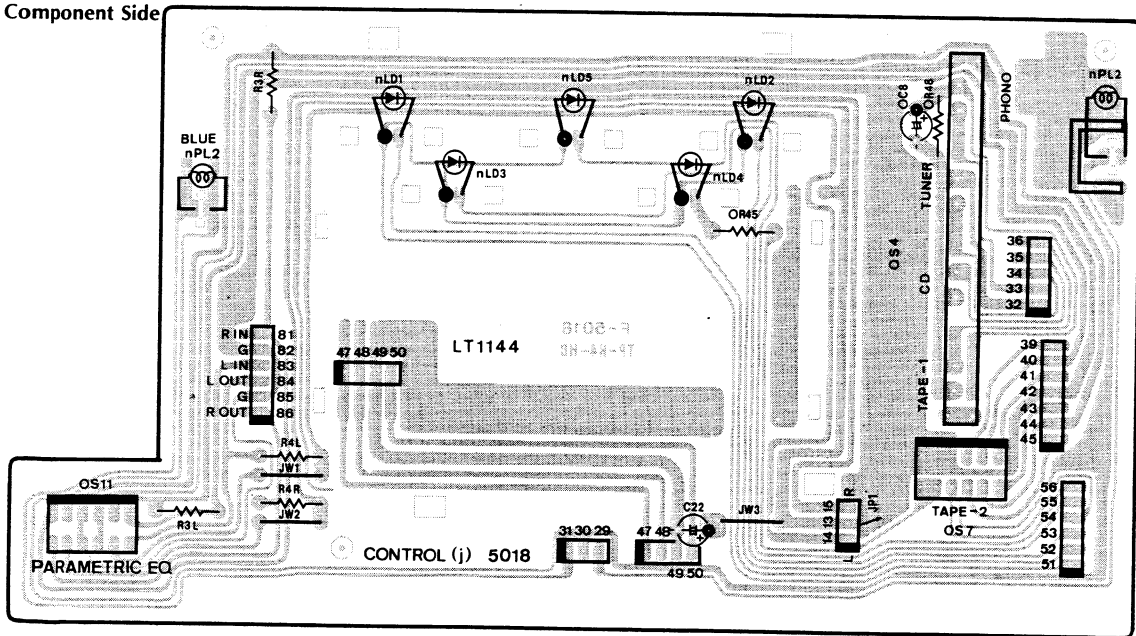

**Parts List**

Parts No.	Stock No.	Description
•LED		
nLD1	48172100	BR3447S
nLD2	48172100	BR3447S
nLD3	48172100	BR3447S
nLD4	48172100	BR3447S
nLD5	48172100	BR3447S

Parts No.	Stock No.	Description
nPL1	48191900	12V 0.15A, Pilot Lamp
nPL2	46286600	12V 0.15A, Pilot Lamp
oS4	48178600	Push SW., INPUT SELECTOR
oS7	46556300	Push SW., REMOTE CONT./TAPE2
oS11	46556300	Push SW., PARAMETRIC EQ.

## 5. OTHER PARTS

### 5-1. Front View

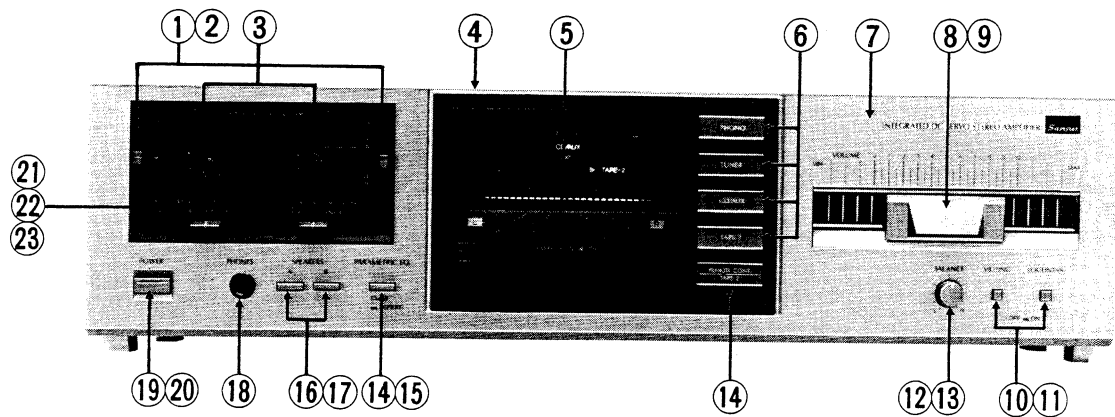

Parts List <Front View>

Parts No.	Stock No.	Description
1	47867700	Knob, HIGH F. Level, LOW F. Level
2	48196700	10k $\Omega$ (B) V.R., HIGH F. Level, LOW F. Level
3	47868700	Cursor Lever Ass'y/PARAMETRIC EQ. HIGH F. & LOW F.
4	47910100	Bonnet for A-900P Silver Model
	47910200	Bonnet for A-900P Black Model & CLASSIQUE A-930P
5	48185810	Power Level Meter
6	48178600	Push SW., PHONO, TUNER, CD/AUX, TAPE-1
7	47871700	Front Panel Ass'y for A-900P Silver Model (XX, XX-V, UL, EU, BS)
	47871800	Front Panel Ass'y for A-900P Black Model (XX, XX-V, UL, EU, BS)
	47871900	Front Panel Ass'y for A-900P Silver Model (CSA)
	47872000	Front Panel Ass'y for A-900P Black Model (CSA)
	47885200	Front Panel Ass'y for CLASSIQUE A-930P
8	47761410	Knob Ass'y, VOLUME for A-900P Silver Model
	47761510	Knob Ass'y, VOLUME for A-900P Black Model & CLASSIQUE A-930P
9	48171000	150k $\Omega$ (B) V.R., VOLUME
10	47763410	Knob, LOUDNESS, MUTING for A-900P Silver Model
	47763510	Knob, LOUDNESS, MUTING for A-900P Black Model & CLASSIQUE A-930P

Parts No.	Stock No.	Description
11	48224600	Push SW., LOUDNESS, MUTING
12	47794600	Knob, BALANCE for A-900P Silver Model
	07895410	Knob, BALANCE for A-900P Black Model & CLASSIQUE A-930P
13	48196400	250k $\Omega$ V.R., BALANCE
14	46556300	Push SW., REMOTE CONT./TAPE-2, PARAMETRIC EQ.
15	47893300	Knob, PARAMETRIC EQ. for A-900P Silver Model
	47893200	Knob, PARAMETRIC EQ. for A-900P Black Model & CLASSIQUE A-930P
16	47894500	Knob, SPEAKERS for A-900P Silver Model
	47560200	Knob, SPEAKERS for A-900P Black Model & CLASSIQUE A-930P
17	46941800	Push SW., SPEAKERS
18	46265700	Jack, PHONES
19	47746800	Knob, POWER for A-900P Silver Model
	47746900	Knob, POWER for A-900P Black Model & CLASSIQUE A-930P
$\Delta$ 20	48113300	Push SW., POWER for A-900P (XX, XX-V, UL, EU, BS) & CLASSIQUE A-930P
$\Delta$ 21	48065100	Push SW., POWER for A-900P (CSA)
22	47867900	Knob, HIGH F. RANGE, LOW F. RANGE
23	48196500	100k $\Omega$ V.R., HIGH F. RANGE, LOW F. RANGE (jVR7, 8)
	48196600	100k $\Omega$ V.R., HIGH F. RANGE, LOW F. RANGE (jVR5, 6)

**5-2. Top View**

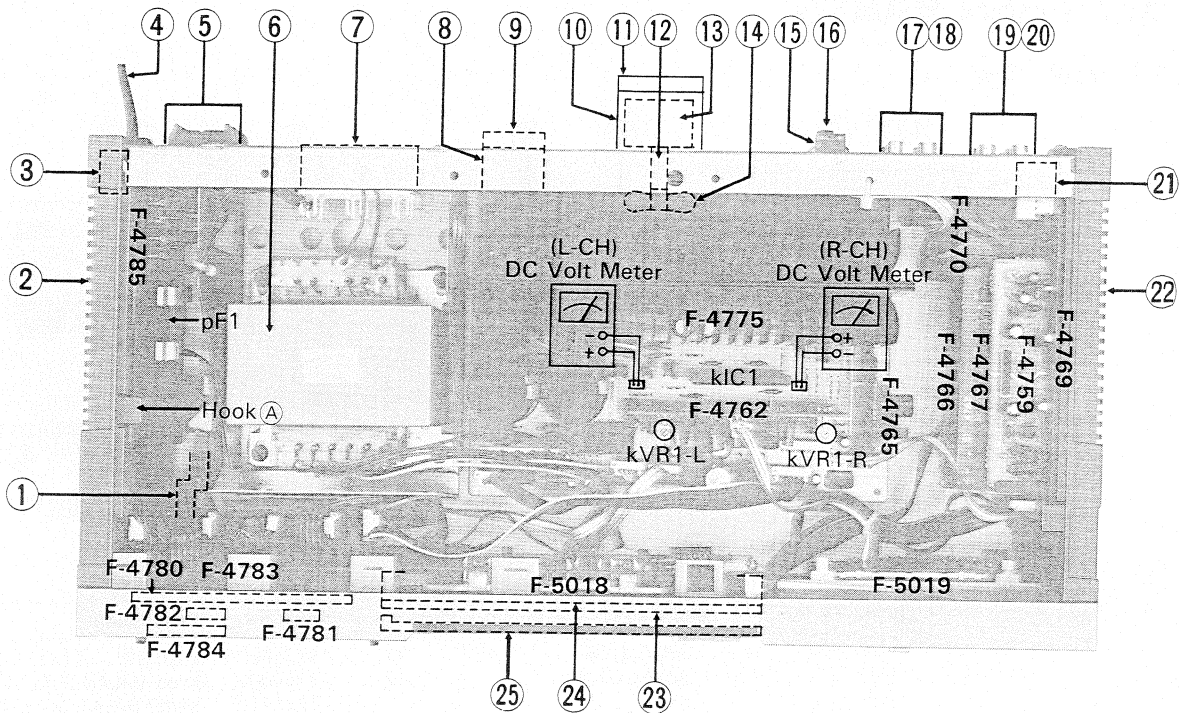

**Parts List <Top View>**

Parts No.	Stock No.	Description
1	47809700	Joint Shaft, Power SW.,
2	47924100	Side Panel Ass'y (Left) for A-900P Silver Model
	47924200	Side Panel Ass'y (Left) for A-900P Black Model & CLASSIQUE A-930P
3	47770900	Power Supply Cord Cover
△ 4	38004700	Power Supply Cord for A-900P (XX, XX-V, UL) & CLASSIQUE A-930P
△	48187800	Power Supply Cord for A-900P (CSA)
△	38004500	Power Supply Cord for A-900P (EU)
△	38004300	Power Supply Cord for A-900P (BS)
5	46947500	8P Terminal, SPEAKERS
6	15020401	Power Transformer for A-900P (XX)
△	15020409	Power Transformer for A-900P (XX-V)
△	15020402	Power Transformer for A-900P (UL, CSA) & CLASSIQUE A-930P
△	15020405	Power Transformer for A-900P (EU, BS)
△ 7	46360100	AC OUTLET for A-900P (XX, XX-V, UL) & CLASSIQUE A-930P
△	48184800	AC OUTLET for A-900P (CSA)
△	46161000	AC OUTLET for A-900P (EU)
△	46364800	AC OUTLET for A-900P (BS)

Parts No.	Stock No.	Description
△ 8	48175400	Socket, VOLTAGE SELECTOR for A-900P (XX-V)
△ 9	48175200	Plug, VOLTAGE SELECTOR for A-900P (XX-V)
10	47808100	Motor Holder for A-900P (EU, BS)
11	47808000	Motor Cover for A-900P (EU, BS)
12	47878000	Spacer for A-900P (EU, BS)
13	46737500	DC Motor for A-900P (EU, BS)
14	07255000	Fan for A-900P (EU, BS)
15	16406800	5P-Terminal, REMOTE CONTRQL
16	22301510	Ground Terminal
17	46438100	2P-Terminal, PHONO
18	46363700	2P-Terminal, TUNER
19	46546800	6P-Terminal, TAPE-1 PLAY, TAPE-2
20	46371500	4P-Terminal, CD/AUX, TAPE-1 REC
21	46670600	Push SW., DECK SELECTOR
22	47768700	Side Panel Ass'y (Right) for A-900P Silver Model
	47874800	Side Panel Ass'y (Right) for A-900P Black Model & CLASSIQUE A-930P
23	47807700	Mask Plate
24	47822400	Mask Plate Holder
25	47807800	Scale Plate, POWER LEVEL METER

# 6. SCHEMATIC DIAGRAM

\*Design and specifications subject to change without notice for improvement.  
\*La présentation et les spécifications sont susceptibles d'être modifiées sans préavis par suites d'améliorations éventuelles.  
\*Änderungen, die dem technischen Fortschritt dienen, bleiben vorbehalten.

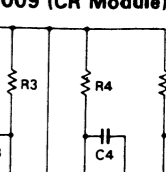
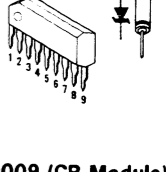
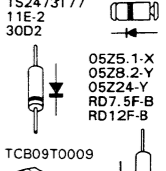
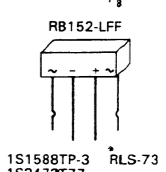
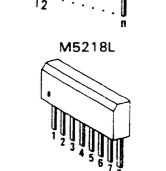
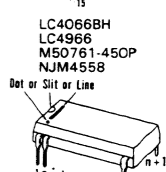
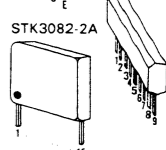
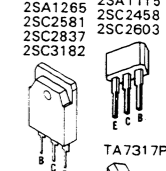
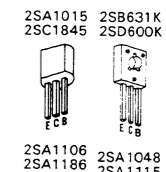
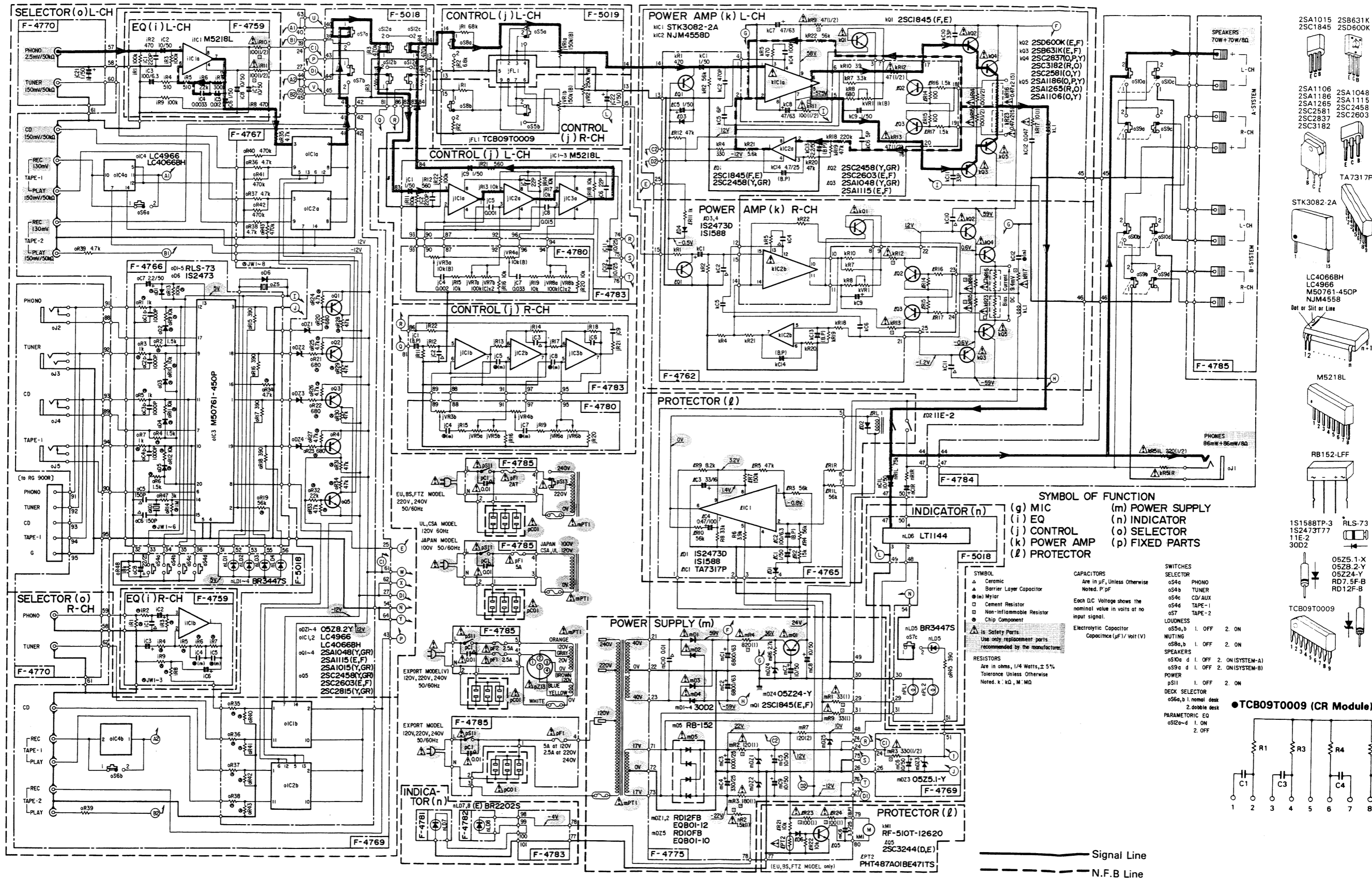

1

2

3

4

5

10

## 7. MAIN PARTS REPLACEMENT

### A. Bonnet (See Fig. 7-1)

- 1) Remove two screws (S).
- 2) Pull the rear side of the bonnet to remove the hooks and then remove bonnet.

Fig. 7-1

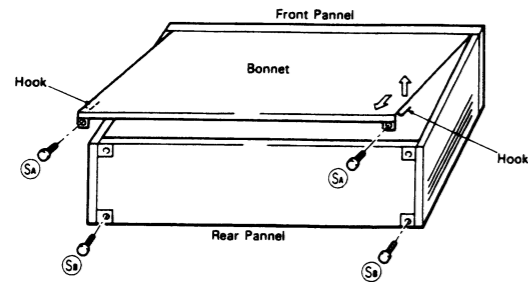

### B. Bottom Plate

- 1) Remove two screws (S) (Fig. 7-1).
- 2) Pull the rear side of the bonnet to remove the hooks and then remove bottom plate.

### C. Side Panel L (R) (See 5-2. Top View on Page 9 & Fig. 7-2)

- 1) Remove bonnet and bottom plate.
- 2) Push up hooks (A) (upper side & bottom side) of side panel ass'y and separate F-4785 board from side panel ass'y.
- 3) Shift the position of the side panel L (R) 1.5cm in the arrow direction (1).
- 4) Remove the hooks (2) of the side panel from front panel and then pull it the arrow direction (3) to remove the side panel L (R).

Fig. 7-2

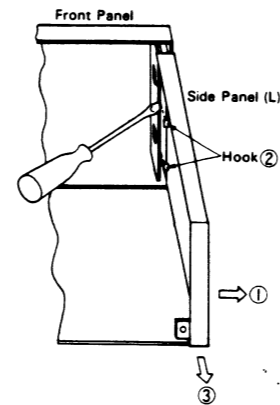

## 8. PACKING LIST

Parts No.	Stock No.	Description
1	47859900	Vinyl Bag
2	47764600	Styrofoam Packing
<Silver Model>		
3	47833100	Carton Case (A-900P XX, UL, CSA, EU, BS)
	47832900	Carton Case (A-900P XX-V)
<Black Model>		
3	47833200	Carton Case (A-900P XX, UL, CSA, EU, BS)
	47833000	Carton Case (A-900P XX-V)
	47834200	Carton Case (CLASSIQUE A-930P)

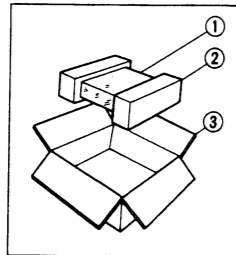

## 9. ACCESSORY LIST

Stock No.	Description
46972200	Operating Instruction for A-900P
46972300	Operating Instruction for CLASSIQUE A-930P
46984300	Operating Sheet